



HotSpring[®]
Portable Spas

Built for a lifetime of relaxation.[®]

HIGHLIFE[®] COLLECTION

***Congratulations on your decision to enjoy the finest spa available...
Welcome to the growing family of HOT SPRING spa owners.***

Pre-Delivery Instructions

Please take the time to read this booklet carefully, as it will provide you with the information you will need to ensure the safe, secure, and timely installation of your new spa. The following sections are guidelines on how to prepare for delivery and set-up of your new spa. Specifically covered are site selection, delivery access, ground preparation, and electrical requirements.

Remember to carefully review the Owner's Manual that accompanies your spa, and to register the spa's warranty within 10 days of delivery. These items, along with other valuable information, will be found in the Owner's Package which has been placed in the equipment compartment of your spa, where you will also find its serial number.

Watkins Manufacturing Corporation reserves the right to change features, specifications and design without notification and without incurring any obligation.

DATE PURCHASED: _____

DATE INSTALLED: _____

DEALER: _____

ADDRESS: _____

TELEPHONE: _____

Register your warranty
using the QR code below:



In most cities and counties, permits will be required for the installation of electrical circuits or the construction of exterior surfaces (decks and gazebos). In addition, some communities have adopted residential barrier codes which may require fencing and/or self-closing gates on the property to prevent unsupervised access to a pool (or spa) by children under 5 years of age. Your **HOT SPRING** spa is equipped with a locking cover that meets the ASTM F1346-91 Standard for Safety Covers and as a result, is usually exempt from most barrier requirements. As a general practice, your local Building Department will inform you of any applicable barrier requirements at the time a permit is obtained for the installation of an electrical circuit. Your Hot Spring dealer can provide information on which permits may be required.

Site Selection and Preparation

IMPORTANT: Site selection and preparation are your responsibility. Carefully read these instructions and consult your authorized **HOT SPRING** dealer if you have any questions.

You probably have a spot picked out for your new spa, whether it's indoors or outdoors, on a patio or on a deck. Just make sure you check the following:

- Always put your spa on a structurally sound, level surface. A filled spa can weigh a great deal. Make certain that the location you choose can support the weight of your filled spa.
- Don't forget to level your spa before filling it. (See Spa Leveling Instructions included in Owner's Manual.)
- Locate your equipment compartment, which houses all of the electrical components, in a place where water will drain away from it. Allowing water into the equipment compartment can damage the electronics, or may result in tripping your house's circuit breaker.
- Leave yourself easy access to the circuit breakers in the subpanel (230 volt models), or to the interrupter switch on the end of the power cord (115 volt models).
- Never let water get into the subpanel (230 volt models), into the interrupter switch (115 volt models), or into the electrical outlet that your spa is plugged into. Your 115 volt **HOT SPRING** spa will come with a protective box designed to keep out rain and water from sprinkler systems. Your 230 volt spa's subpanel is raintight when installed correctly with the door closed.
- Leave access to the equipment compartment for periodic spa care and maintenance.

OUTDOOR AND PATIO INSTALLATION

No matter where you install your new spa, it's important that you have a solid foundation to support it. Structural damage to the spa resulting from incorrect installation or placement on an inadequate foundation is not covered under the spa's limited warranty.

If you install the spa outdoors, a reinforced concrete pad at least four inches thick is required for the Grandee® spa, and recommended for the Envoy®, Vanguard®, Aria®, Sovereign®, Prodigy® and Jetsetter® spas. The reinforcing rod or mesh in the pad should be attached to a bond wire (see your Owner's Manual). All Hot Spring spas may be installed onto a deck, provided that the load capacity of the deck is greater than the dead weight of the spa (see Deck Installation).

If you place the spa on the ground, even temporarily, place stepping stones under the leveling areas (see Spa Leveling Instructions in your Owner's Manual). The stones should be at least two inches thick and twelve inches square. Even with stones in place, the spa will inevitably settle and become unlevel. Plus, a spa surrounded by dirt or grass will soon be filled with dirt or grass from users' feet; therefore, it is important to get it onto a solid foundation as soon as possible.

DECK INSTALLATION

To be certain your deck can support your spa, you must know the deck's maximum load capacity. **Consult a qualified building contractor or structural engineer before you place the spa on an elevated deck or indoors.** To find the weight of your spa, its contents and occupants, refer to the Spa Specification chart. This weight per square foot must not exceed the structure's rated capacity, or serious structural damage could result.

INDOOR INSTALLATION

Be aware of some special requirements if you place your spa indoors. Water will accumulate around the spa, so flooring materials must provide a good grip when wet. Proper drainage is essential to prevent a build-up of water around the spa. When building a new room for the spa, it is recommended that a floor drain be installed. The humidity will naturally increase with the spa installed. Water may get into woodwork and produce dryrot, mildew, or other problems. Check for airborne moisture's effects on exposed wood, paper, etc. in the room. To minimize these effects, it is best to provide plenty of ventilation to the spa area. An architect can help to determine if more ventilation must be installed.

Your **HOT SPRING** dealer can help you with local information such as zoning regulations and building codes.

DELIVERY ACCESS

First, locate the dimensions of your spa on the following chart. The dimensions shown are the measurements of the spa in the vertical position, laid on its side.

Next, contact your dealer to find the height and width added by the delivery cart which the dealer will use to deliver your new spa. Use the height of the cart plus the dimension shown as H to determine the vertical clearance required to pass the spa and cart. Use the width of the cart, or dimension W, whichever is greater, to determine the maximum width of clearance necessary.

NOTE: It may be necessary to allow for additional over-head clearance if the spa will be rolled up or down an incline or moved up or down a short flight of stairs.

Use the information below to determine the requirements for access to your desired location.

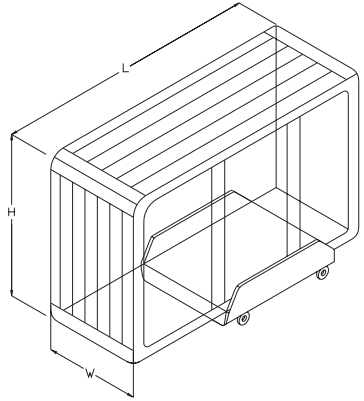

<i>Model</i>	<i>Width W</i>	<i>Length L</i>	<i>Height H</i>
GRANDEE (GG)	38"	8'4"	7'7"
ENVOY (KK)	38"	7'9"	7'7"
VANGUARD (VV)	36"	7'3"	7'3"
ARIA (AR)	36"	7'3"	7'3"
SOVEREIGN (II)	33"	7'9"	6'8"
PRODIGY (H)	33"	7'0"	6'6"
JETSETTER (JJ)	29"	7'0"	5'5"

How is your width clearance?

Check all gates

Protruding electric meters

Gas meters

A/C units

Do you have sufficient overhead clearance?

Check low roof eaves, overhanging branches, rain gutters

Is the path clear?

Move away branches, dog houses, firewood, etc.

If there is a 90° turn, can we clear it? (The spa will not bend)

No more than 6 consecutive stairs without a landing

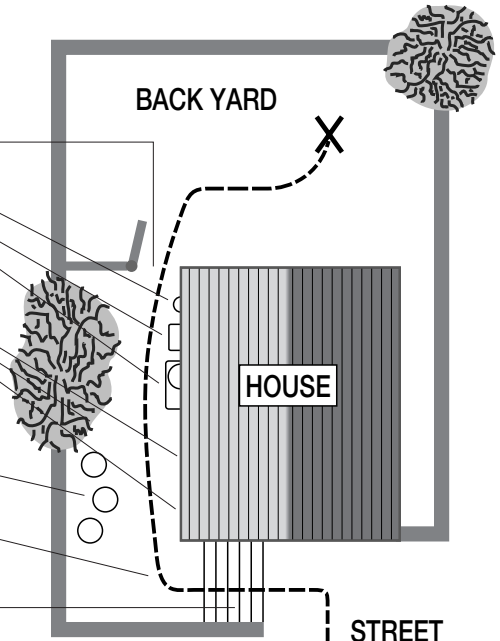

It may be necessary to remove a gate, part of a fence, or other movable obstructions in order to roll the spa to its installation site. About ten percent of the time, a crane is the only way to install the spa by lifting it to its final destination.

If the spa has to be taken off of the cart to go over a wall (either because the entry area is too narrow, the eaves are too low, the corner is too tight, or the stairway is too steep), a crane will be required. Don't be alarmed!

The crane has a truck-mounted boom which can fit right in your driveway. It is run by a licensed and insured operator. For a charge, the crane operator will lift your spa over walls, buildings, or any other obstruction and place it as close to the installation site as possible. The **HOT SPRING** spa delivery personnel will supervise the crane delivery and complete the spa installation. Crane delivery typically takes an average of 30 minutes to complete.

NOTE: If your spa delivery requires the use of a crane, you may be required to pay for its services at the completion of the delivery.

GROUND PREPARATION

Your Hot Spring spa has been engineered to perform on all kinds of common yard surfaces. While a concrete slab is best for long-term use*, other foundations are acceptable so long as a level base is prepared prior to delivery. Three foundation base pictures, shown at right, represent examples of alternatives to a concrete slab for spas installed without gazebos or other accessories.

***NOTE:** A reinforced concrete pad at least four inches thick or a deck that is able to withstand more than 125 lbs. per square foot is required for the **GRANDEE** spa, and recommended for the **ENVOY**, **VANGUARD**, **ARIA**, **SOVEREIGN**, **PRODIGY** and **JETSETTER** spas.

INSTALLATION NOTES:

- If stepping stones or railroad ties are selected for the spa foundation, they should be placed at the designated leveling areas of your spa to maintain even distribution of the spa weight.
- It is important to note that soft surfaces, even when stepping stones are used to distribute the weight of the spa as evenly as possible, will still have a tendency to settle unevenly, resulting in an unlevel spa.
- Remember, placing the spa on grass or dirt may increase the amount of debris which is inadvertently brought into the spa water on the user's feet.

If you are purchasing a deck package or a gazebo with your spa, a solid foundation becomes mandatory. Placing them on any surface other than a single level pad could create problems with their installation. Pictured at right are a few of the recommended surfaces.

As a homeowner, it is your responsibility to provide a suitable, level foundation for your spa. Keep in mind that most delivery crews are not equipped to level and prepare spa sites.

If you are interested in having a concrete slab, brick surface, or wood deck installed, your **HOT SPRING** dealer should be able to suggest a qualified, licensed contractor.

NOTE: In order for the spa to operate properly and the internal plumbing to drain completely, you must ensure that the spa is leveled after it has been installed. The diagrams on the following pages indicate the recommended shimming points on your spa's base support system. Your **HOT SPRING** spa delivery crew can help you perform the procedure.

FOUNDATIONS FOR SPAS ONLY (No accessories such as cover or gazebo)

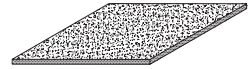

PEA GRAVEL
OR CRUSHED ROCK

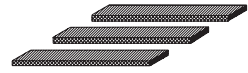

RAILROAD TIES



PRE-CAST
STEPPING STONES

FOUNDATIONS FOR SPAS WITH ACCESSORIES

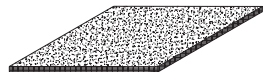

CONCRETE PADS

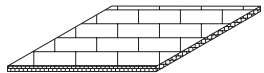

BRICK SURFACES



WOOD DECKING

GRANDEE (MODEL GG)

Dimensions

NOTE: All dimensions are approximate; measure your spa before making critical design or pathway decisions.

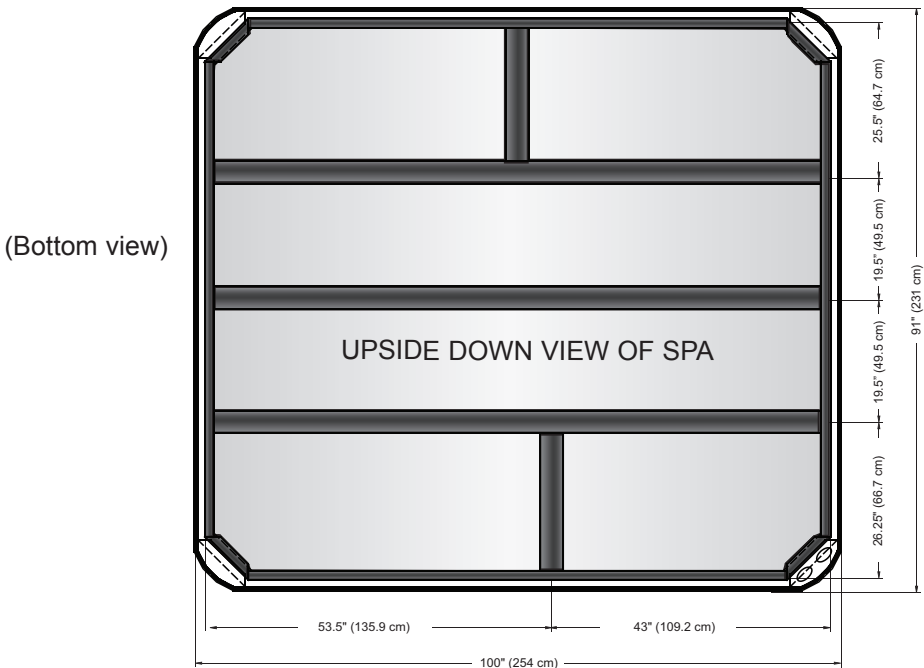
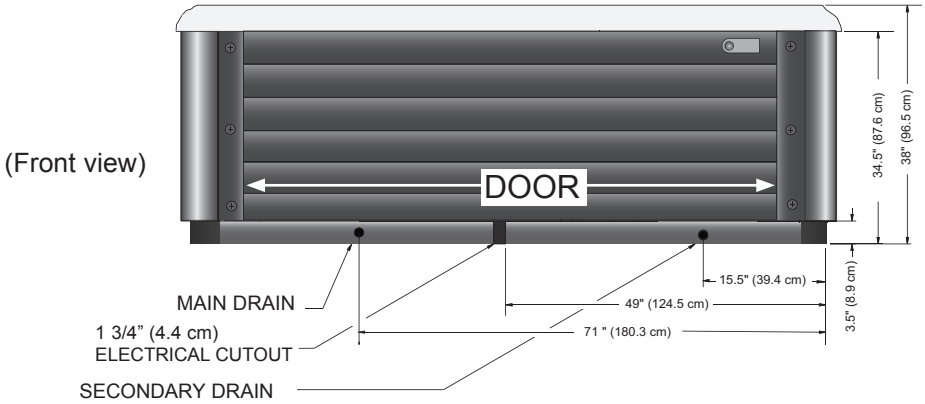

DOOR SIDE

NOTE: Watkins Manufacturing Corporation requires that the **GRANDEE** be installed on a minimum 10 cm (4") thick reinforced concrete pad or a deck that is able to withstand more than 555 kg/m² (115 lbs. per square foot).

WARNING: The **GRANDEE** must not be shimmed in any manner.

ENVOY (MODEL KK)

Dimensions

NOTE: All dimensions are approximate; measure your spa before making critical design or pathway decisions.

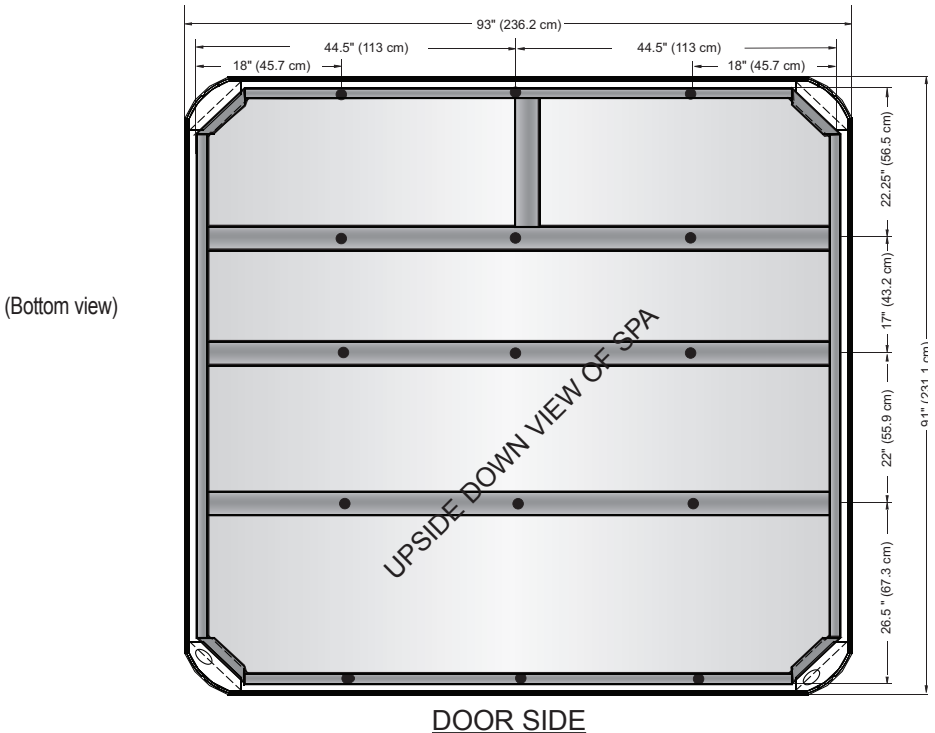
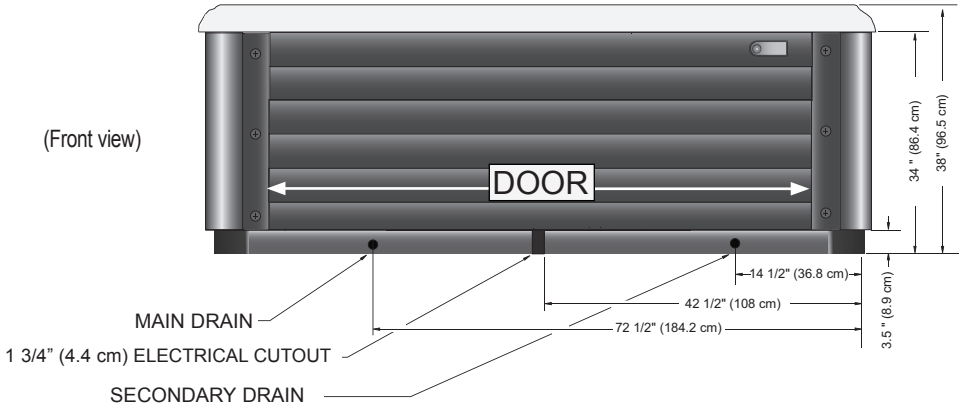

- 15 leveling points (place shims at illustrated locations).

VANGUARD (Model VV) & ARIA (Model AR)

Dimensions

NOTE: All dimensions are approximate; measure your spa before making critical design or pathway decisions.

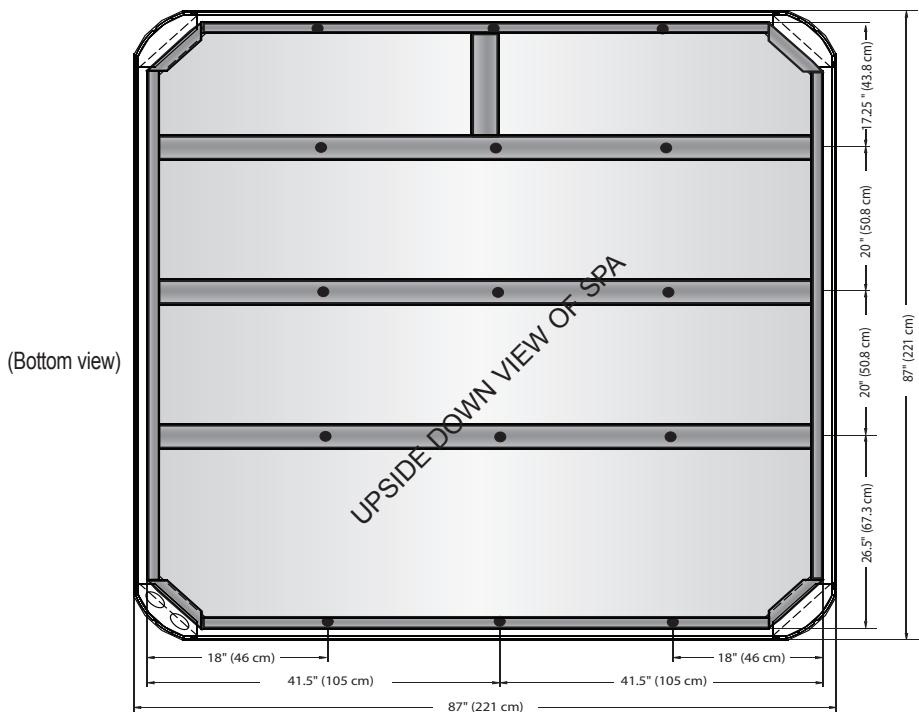
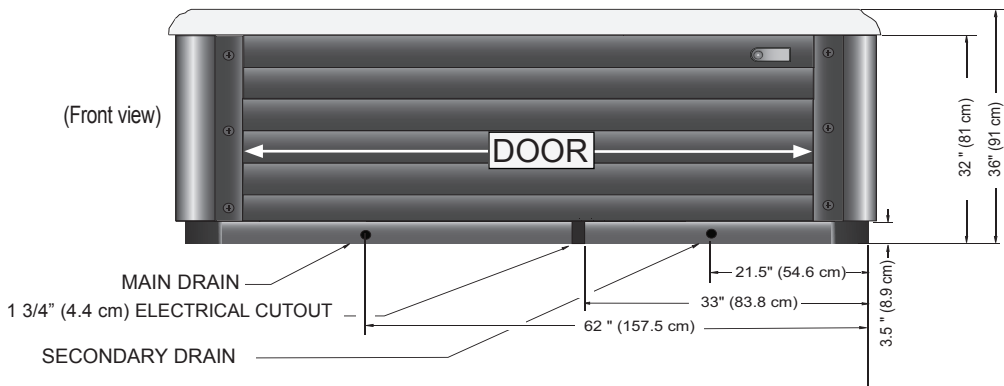

DOOR SIDE

- 15 leveling points (place shims at illustrated locations).

SOVEREIGN (Model II)

Dimensions

NOTE: All dimensions are approximate; measure your spa before making critical design or pathway decisions.

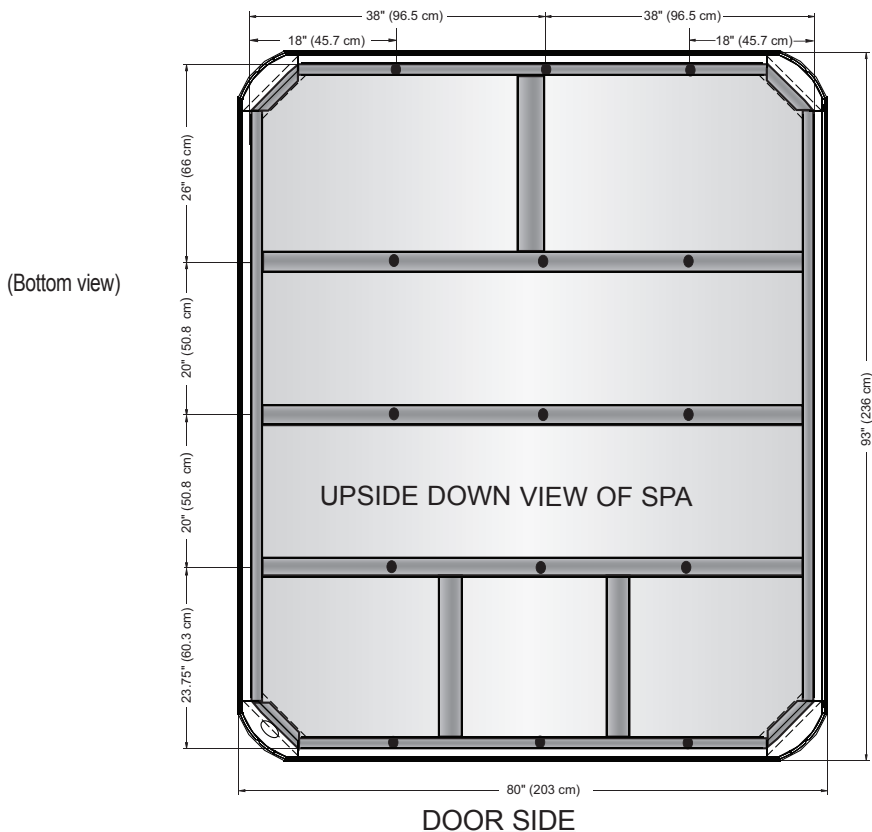
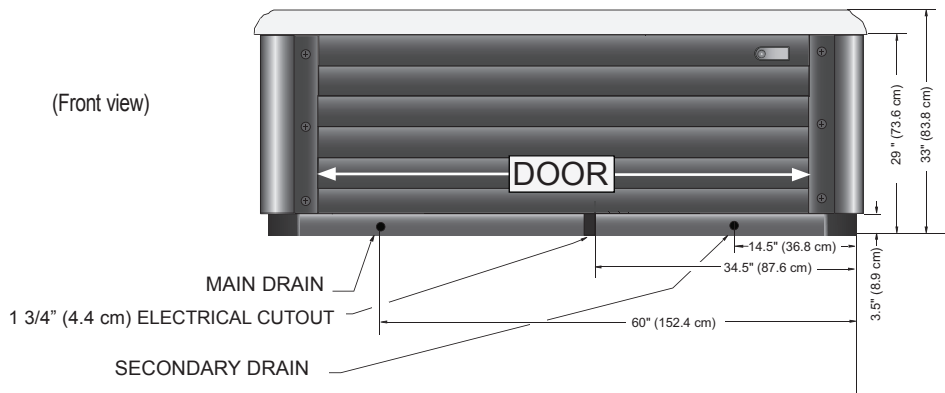

- 15 leveling points (place shims at illustrated locations).

JETSETTER (Model JJ)

Dimensions

NOTE: All dimensions are approximate; measure your spa before making critical design or pathway decisions.

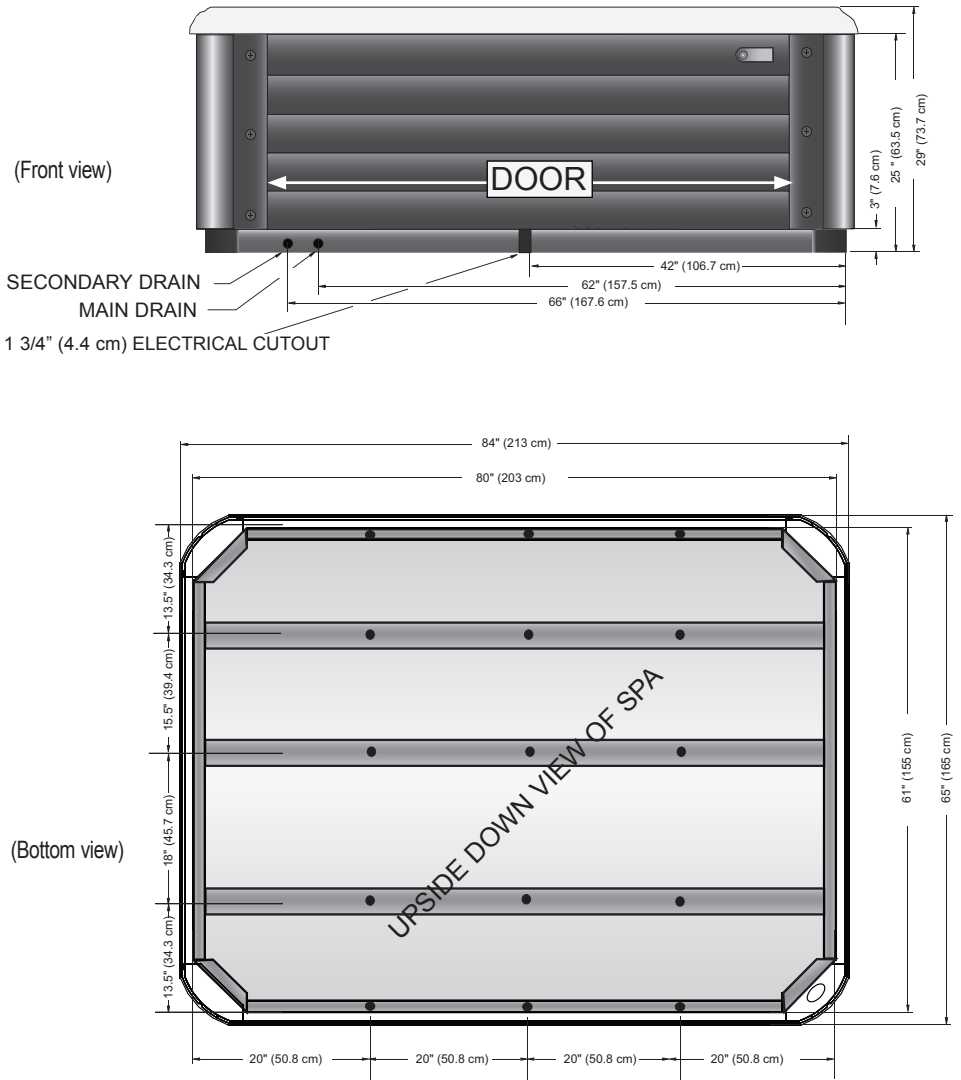

- 15 leveling points (place shims at illustrated locations).

ELECTRICAL REQUIREMENTS

To ensure you will have an opportunity to use your spa soon after delivery, it is very important that the required electrical service has been installed. Unless otherwise stipulated by your dealer, **THIS IS YOUR RESPONSIBILITY.**

IMPORTANT: All electrical circuits must be installed by a qualified, licensed electrician.

HOT SPRING spas are manufactured in two different electrical versions. The **GRANDEE, ENVOY, VANGUARD, ARIA** and **SOVEREIGN** models are available with a 230 volt continuous heating system. These spas cannot be converted to 115 volt operation.

The remaining spa model, the **PRODIGY & JETSETTER** models are available as 115/230 volt convertible heating systems. This models comes standard from the factory with 115 volt heating systems; however, with the addition of a subpanel and a control box wiring change, they can be converted to 230 volt operation. See the following sections for the electrical requirements for 115 volt operation, 230 volt operation and 230 volt converted operation.

115 VOLT OPERATION REQUIREMENTS

The 115 volt spa requires a dedicated 20 amp, 115 volt circuit. This circuit must be properly wired; that is, it must have a 20 amp GFCI breaker in the main electrical service panel, and #12 AWG wire (including ground wire) and the correct polarity throughout the circuit.

WIRE SPECIFICATION NOTE: Long electrical runs may require a larger gauge feed wire than stated. We recommend that a maximum voltage drop of 3% be used when calculating the larger wire size.

NOTE: The term “dedicated” means that only the spa operates on the circuit.

Each 115 volt model comes equipped with approximately 15 feet of usable power cord. (This is the maximum length allowed by Underwriters Laboratory.) When the spa is installed, the power cord will come out of the bottom of the equipment compartment.

In addition to the dedicated 20 amp, 115 volt GFCI protected circuit, your spa requires a 20 amp single receptacle. This receptacle, which contains an outdoor-rated, weather-resistant receptacle cover plate, will be provided to you. The single receptacle and cover plate should be installed by your electrician prior to the delivery of your spa.

For your safety, when your electrician is installing the electrical outlet, it should be no closer than five (5) feet and no farther than ten (10) feet from the spa. (Reference National Electric Code 680-6a(1) and 680-41a.)

WARNINGS: Do not connect your spa to an extension cord!

The 115 volt GFCI switch and the receptacle must be protected from weather and landscape sprinklers—they should never get wet.

NOTE: If you require the services of a licensed electrician, your **HOT SPRING** Dealer should be able to suggest one for you.

Your **HOT SPRING** spa has been carefully engineered to provide maximum safety against electric shock. Remember, connecting the spa to an improperly wired circuit will negate many of its safety features.

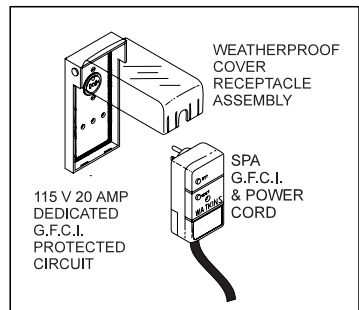
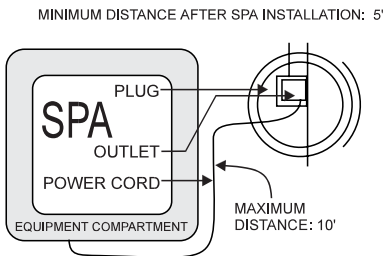

230 VOLT OPERATION REQUIREMENTS

All models require a 50 amp, single phase, 230 volt circuit breaker in the main electrical service panel.

All 230 volt Hot Spring spas must be wired in accordance with applicable local and national electrical codes, all electrical work must be done by a licensed electrician.

NOTE: Watkins Manufacturing Corporation REQUIRES THE USE OF A SUBPANEL TO SUPPLY POWER AND PROTECT THE SPA. On the **GRANDEE, ENVOY, VANGUARD, ARIA** and **SOVEREIGN** models, the subpanel containing GFCI breakers is included with the spa. On the 230 volt **JETSETTER** model, the subpanel containing GFCI breakers must be purchased separately and can be purchased from your **HOT SPRING** dealer.

A licensed electrician should install a four-wire electrical service (two line voltages, one neutral, one ground) from the main electrical service panel to the subpanel, and from the sub-panel to the spa per the appropriate wiring diagram as illustrated below.

The grounding conductor must be at least #10 AWG. Your electrician should mount the subpanel in the vicinity of the spa but it should not be closer than five (5) feet from the spa water edge (NEC 680-38 to 41-A-3).

INSTALLATION NOTE: After the spa has been installed by the dealer's delivery crew, your electrician can connect the conduit from the subpanel to the spa's IQ 2020[®] Control Box and then complete the wiring connections in the control box.

IMPORTANT NOTE: Three different wiring diagrams are shown: one for **GRANDEE, ENVOY, VANGUARD & ARIA** models. One for the **SOVEREIGN** model, and one for the **PRODIGY & JETSETTER** models. Always follow the wiring diagram for your specific model.

NOTE: Complete step-by-step Installation and Wiring Instructions for all 230 volt Hot Spring models are included in the Owner's Manual and with each sub-panel, which can be obtained from your dealer.

WARNING: Removing or bypassing the GFCI breakers in the subpanel at any time will result in an unsafe spa and will void the warranty.

WIRE SPECIFICATION NOTE: Long electrical runs may require a larger gauge feed wire than stated. We recommend that a maximum voltage drop of 3% be used when calculating the larger wire size.

Refer to the Wiring Diagrams to the right for the electrical requirements of the 230 volt models.

When connecting the supply conduit to the bottom of the **IQ 2020** box, use a 3/4" liquid-tight flex conduit fitting.

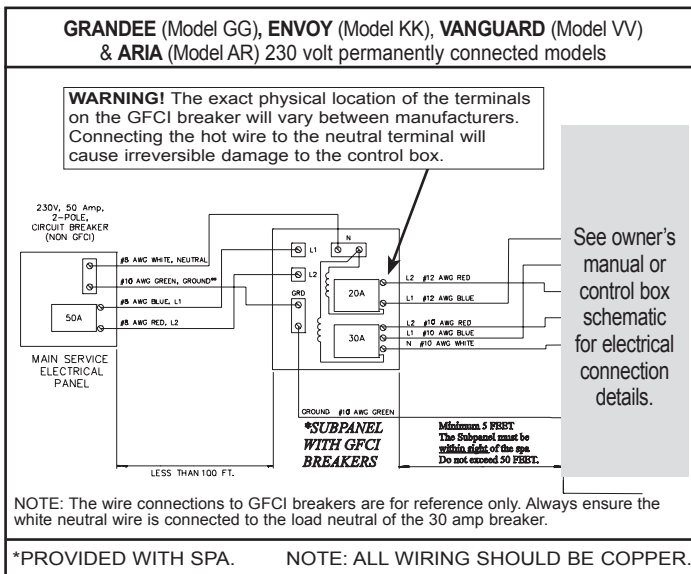

SOVEREIGN (Model II)
230 volt permanently connected models

WARNING! The exact physical location of the terminals on the GFCI breaker will vary between manufacturers. Connecting the hot wire to the neutral terminal will cause irreversible damage to the control box.

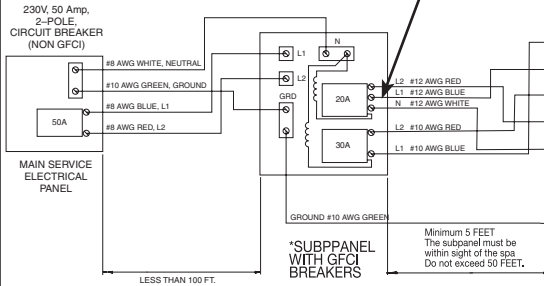

See owner's manual or control box schematic for electrical connection details.

NOTE: The wire connections to GFCI breakers are for reference only. Always ensure the white neutral wire is connected to the load neutral of the 20 amp breaker.

*PROVIDED WITH SPA. NOTE: ALL WIRING SHOULD BE COPPER.

PRODIGY (Model H) & JETSETTER (Model JJ)
230 volt converted models

WARNING! The exact physical location of the terminals on the GFCI breaker will vary between manufacturers. Connecting the hot wire to the neutral terminal will cause irreversible damage to the control box.

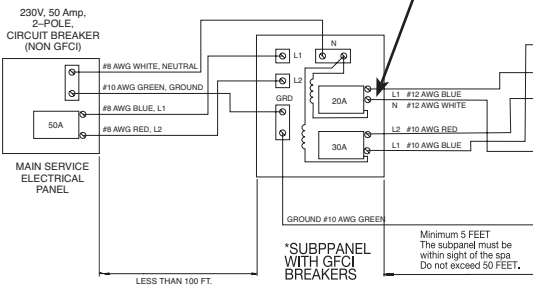

See owner's manual or control box schematic for electrical conversion and connection details.

NOTE: The wire connections to GFCI breakers are for reference only. Always ensure the white neutral wire is connected to the load neutral of the 20 amp breaker.

*AVAILABLE FROM DEALER. NOTE: ALL WIRING SHOULD BE COPPER.

WIRE INSTALLATION FOR CONTROL BOX TERMINAL BLOCK

(Layout of Spa's Terminal Blocks may vary)

Wire Installation Steps

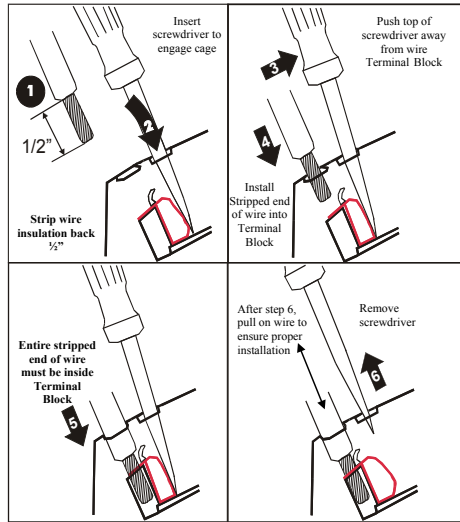

Refer to spa's wiring diagram on back of Control Box Cover for proper wiring and jumper configuration!

SERVICES AVAILABLE FROM YOUR HOT SPRING SPA DEALER

Service

Cost

Pre-Delivery site inspection	_____
Deliver spa to installation site	_____
Unwrap spa and haul away packaging material	_____
Set up & level spa	_____
Fill the spa with water	_____
Connect the spa to its power source (115 volt models)	_____
Explain and test the spa's operation	_____
<ul style="list-style-type: none"> • Jet system • Set temperature control 	<ul style="list-style-type: none"> • Moto-Massage® jet • Control panel functions
<ul style="list-style-type: none"> • GFCI 	<ul style="list-style-type: none"> • Comfort Control® system • Heater high limit • Heater thermal cut-off
Explain the safety features	_____
General spa operation & maintenance orientation	_____
Water quality and maintenance orientation	_____
Adjust the water's Total Alkalinity, Calcium Hardness and pH	_____
Sanitize the water	_____
Inspect the spa cover, place on spa	_____
Review winterizing instructions	_____
Review Owner's Manual & Warranty Card	_____
Follow-up call	_____
In-store spa water analysis	_____
In-store spa water analysis	_____
TOTAL COST	_____

ADDITIONAL PRODUCTS AVAILABLE FROM YOUR HOT SPRING SPA DEALER

- ACE® Salt Water Sanitizing System
- EverFresh® water care system featuring the FreshWater® III high output ozone, MPS, and FreshWaterAg+ Silver Ion Cartridge
- Clean Screen® Pre-filter
- Vanishing Act® Calcium Remover
- **FRESHWATER** Bottled Water Care Products
- **FRESHWATER** Test Strips
- **FRESHWATER** Instant Filter Cleaner and Filter Cleaner
- **FRESHWATER** Spa Shine
- **FRESHWATER** CoverShield
- Retractable cover systems including the CoverCradle®, CoverCradle II, UpRite and Lift'n Glide® systems.
 - Cover Cradle - 24" Clearance required
 - Cover Cradle II - 24" Clearance required
 - UpRite - 7" Clearance required
 - Lift 'n Glide - 14" Clearance required
- Vinyl covers
- Spa steps
- Replacement filter cartridges
- Pillows

CONTRACTOR SUGGESTIONS

Electrician

Name: _____
Telephone: _____
Name: _____
Telephone: _____

Masonry

Name: _____
Telephone: _____
Name: _____
Telephone: _____

General

Name: _____
Telephone: _____
Name: _____
Telephone: _____

Spa Specifications

	Footprint dimensions	Height	Effective filter area	Heater (Watts)	Water capacity	Dry weight	Filled weight*	Dead weight*	Electrical requirements
GRANDEE (Model GG) Seats 7 Adults	7' 7" x 8' 4" 2.31m x 2.54m	38" 97cm	325 Square Feet	4,000	500 gallons 1,893 liters	1060 lbs. 480 kg	6,455 lbs. 2,928 kg	125 lbs. per square foot	230 v System, 230 volt, 50 single phase GFCI protected circuit
ENVOY (Model KK) Seats 5 Adults	7' 9" x 7' 7" 2.36m x 2.31m	38" 97cm	325 Square Feet	4,000	450 gallons 1,514 liters	950 lbs. 430 kg	5,578 lbs. 2,530 kg	120 lbs. per square foot	230 v System, 230 volt, 50 single phase GFCI protected circuit
VANGUARD (Model VV) Seats 6 Adults	7' 3" Sq. 2.20m Sq.	36" 91cm	325 Square Feet	4,000	400 gallons 1,514 liters	820 lbs. 371 kg	5,206 lbs. 2,361 kg	135 lbs. per square foot	230 v System, 230 volt, 50 single phase GFCI protected circuit
ARIA (Model AR) Seats 5 Adults	7' 3" Sq. 2.20m Sq.	36" 91cm	325 Square Feet	4,000	365 gallons 1,382 liters	820 lbs. 371 kg	4,739 lbs. 2,150 kg	125 lbs. per square foot	230 v System, 230 volt, 50 single phase GFCI protected circuit
SOVEREIGN (Model II) Seats 6 Adults	6' 8" x 7' 9" 2.03m x 2.36m	33" 84cm	120 Square Feet	6,000	355 gallons 1,344 liters	745 lbs. 337 kg	4,756 lbs. 2,157 kg	120 lbs. per square foot	230 v System, 230 volt, 50 single phase GFCI protected circuit
PRODIGY (Model H) Seats 5 Adults	6' 6" x 7' 0" 2.03m x 2.36m	33" 84cm	90 Square Feet	1,500 or 6,000	325 gallons 1,230 liters	645 lbs. 293 kg	4,231 lbs. 1,919 kg	120 lbs. per square foot	115 volt, 20 amp Dedicated GFCI protected circuit 230 volt, 50 amp single phase GFCI protected circuit
JETSETTER (Model JJ) Seats 3 Adults	5'5" x 7'0" 2.26m x 2.26m	29" 74cm	90 Square Feet	1,500 or 6,000	225 gallons 852 liters	476 lbs. 215 kg	2,877 lbs. 1,305 kg	100 lbs. per square foot	115 volt, 20 amp Dedicated GFCI protected circuit 230 volt, 50 amp single phase GFCI protected circuit

CAUTION: Watkins Manufacturing Corporation suggests a structural engineer or contractor be consulted before the spa is placed on an elevated deck.

* **NOTE:** The "Filled weight" and "Dead weight" of the spa includes the weight of the occupants (assuming an average occupant weight of 175 lbs).

**Effective filter area is based on 6.5 square feet actual area per filter with 10 times effectivity rating.

Watkins[®]

The Home Relaxation Specialists

WATKINS MANUFACTURING CORPORATION

1280 Park Center Drive

Vista, California 92081

(800) 999-4688 extension 8432

©2014 Watkins Manufacturing Corporation. Hot Spring, Built for a lifetime of relaxation, Moto-Massage, Highlife, Grandee, Envoy, Vanguard, Aria, Sovereign, Prodigy, Jetsetter, AutoFresh, Comfort Control, CoverCradle, GlideRite, Lift'nGlide, UpRite, IQ 2020, CoverShield, ACE, EverFresh, FreshWater, Vanishing Act and The Home Relaxation Specialists are trademarks of Watkins Manufacturing Corporation.

Part #62904.14 Rev. A (5/14)